

# 0857 DEUTSCH CONNECTOR ASSEMBLY

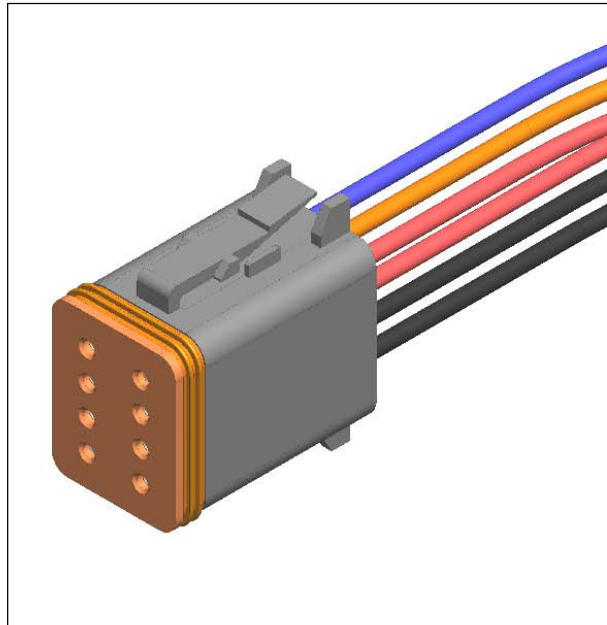

**FOR USE WITH GX AND MX SENSING CONTACTORS  
FEATURING INTEGRATED DT08 DEUTSCH CONNECTOR**

**GIGAVAC**<sup>®</sup>  
ADVANCED SWITCHING SOLUTIONS

# 0857 (ASSEMBLED)

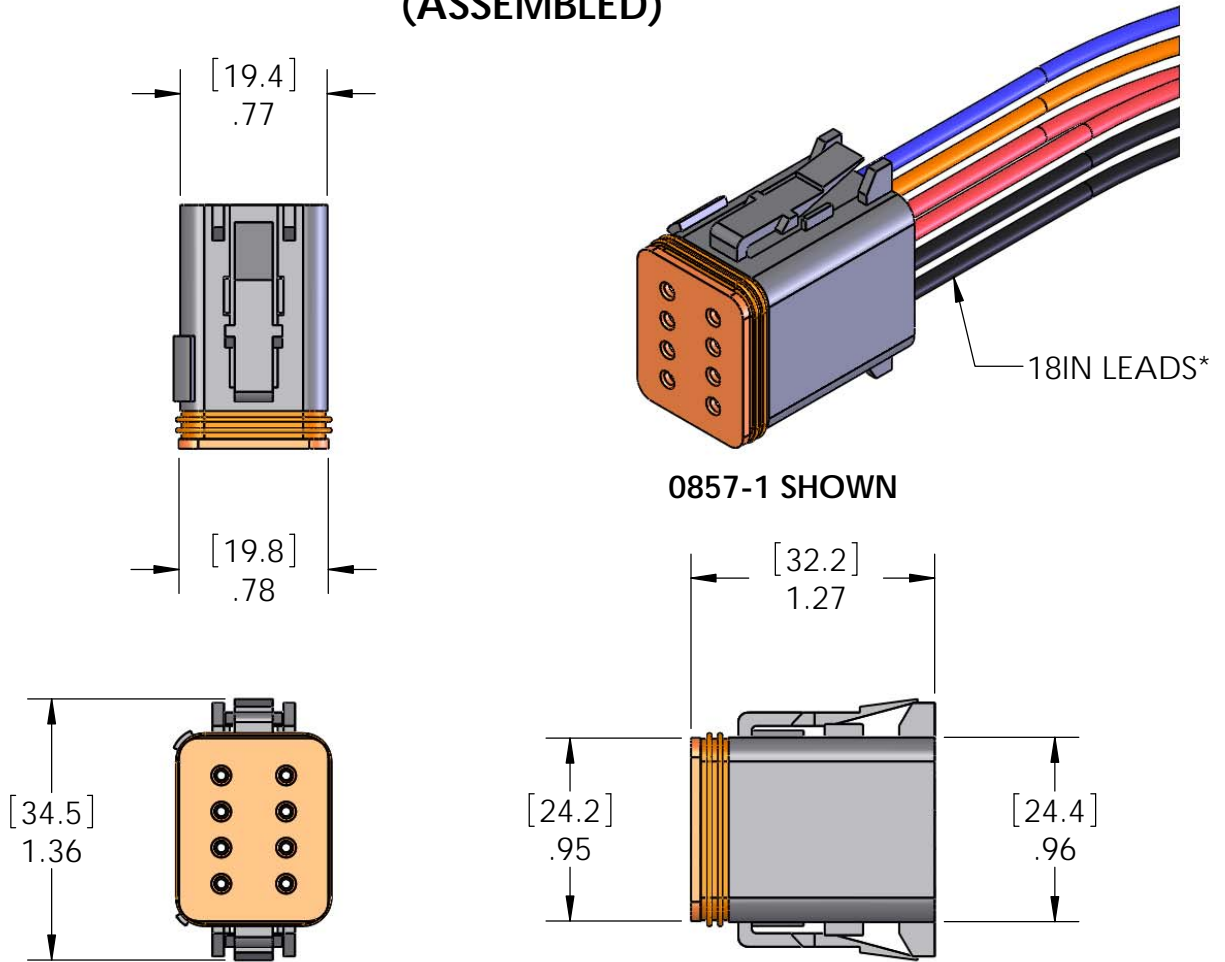

| <u>PART NUMBER</u> | <u>DESCRIPTION</u>                    |
|--------------------|---------------------------------------|
| 0857-1             | CURRENT SENSE                         |
| 0857-2             | CURRENT SENSE WITH AUXILIARY          |
| 0857-3             | OVER CURRENT                          |
| 0857-4             | OVER CURRENT WITH AUXILIARY           |
| 0857-5             | LOW VOLTAGE DISCONNECT                |
| 0857-6             | LOW VOLTAGE DISCONNECT WITH AUXILIARY |
| 0857-7             | DELAY ON BREAK                        |
| 0857-8             | DELAY ON BREAK WITH AUXILIARY         |
| 0857-9             | CAN-BUS                               |
| 0857-10            | CAN-BUS WITH AUXILIARY                |

SEE SHEET 3 FOR PINOUT CONFIGURATIONS

## MATING CONNECTOR

DEUTSCH CONNECTOR HOUSING P/N: DT06-08SA  
 SOLID CONTACT SOCKET P/N: 0462-201-16141  
 WEDGE LOCK P/N: W8S  
 SEALING PLUG P/N: 114017

## LEADS\*

UL3239 20AWG WIRE, 18 INCHES

# PINOUT CONFIGURATIONS

0857-1  
Current Sense

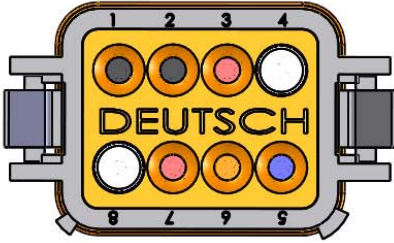

0857-2  
Current Sense with Auxiliary

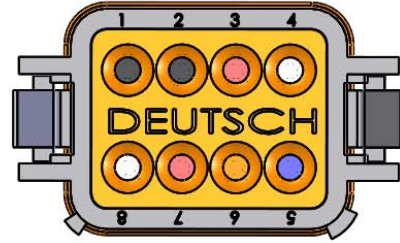

0857-3  
Over Current

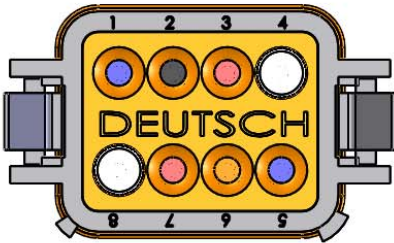

0857-4  
Over Current with Auxiliary

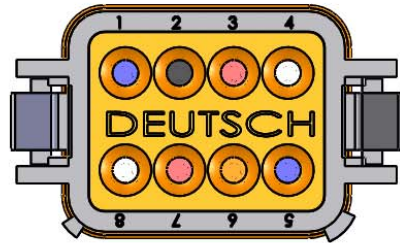

0857-5  
Low Voltage Disconnect

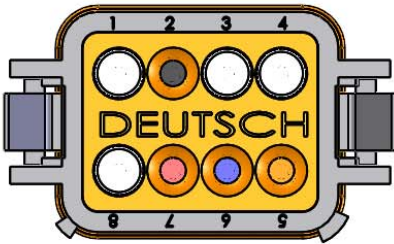

0857-6  
Low Voltage Disconnect with Auxiliary

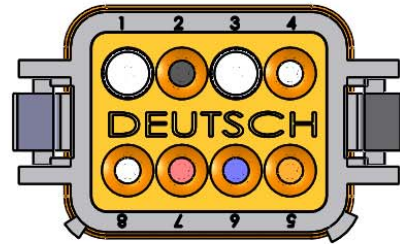

0857-7  
Delay on Break

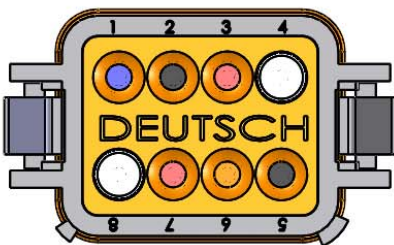

0857-8  
Delay on Break with Auxiliary

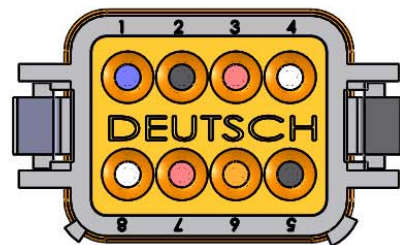

0857-9  
CAN-Bus

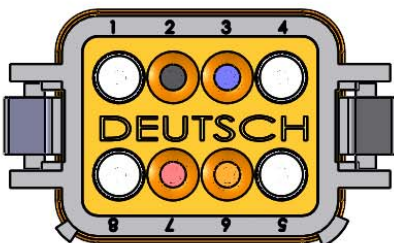

0857-10  
CAN-Bus with Auxiliary

