

CD60 potentiometric output – Measurement range 0 up to 1500 mm

Specifications:

Measurement range	0 up to 1500 mm
Output signal	1k Ω potentiometer (other values on demand)
Resolution	Quasi infinite (depends on the operating system)
Material	Body and cover - Aluminium (RohS) Measuring cable – Stainless steel
Cable diameter	0,60 mm
Detection element	Multi-turn Hybrid potentiometer
Connection	Male connector M16 – DIN 3 pin Male connector M12 – 4 pin PVC cable – 4 wires
Standard linearity	+/- 0,15% f.s. +/- 0,10% f.s. (optional)
Protection class	IP54 (option IP67)
Max. Velocity	10 m/s
Max. Acceleration	20 m/s ² (before cable deformation)
Weight	\approx 1000 g
Operating temperature	-20° to +80°C
Storage temperature	-30° to +80°C



Cable forces:

Measurement range in mm	Min. pull-out force	Max. pull-out force
1500	\approx 9,00 N	\approx 12,00 N

Ordering reference:

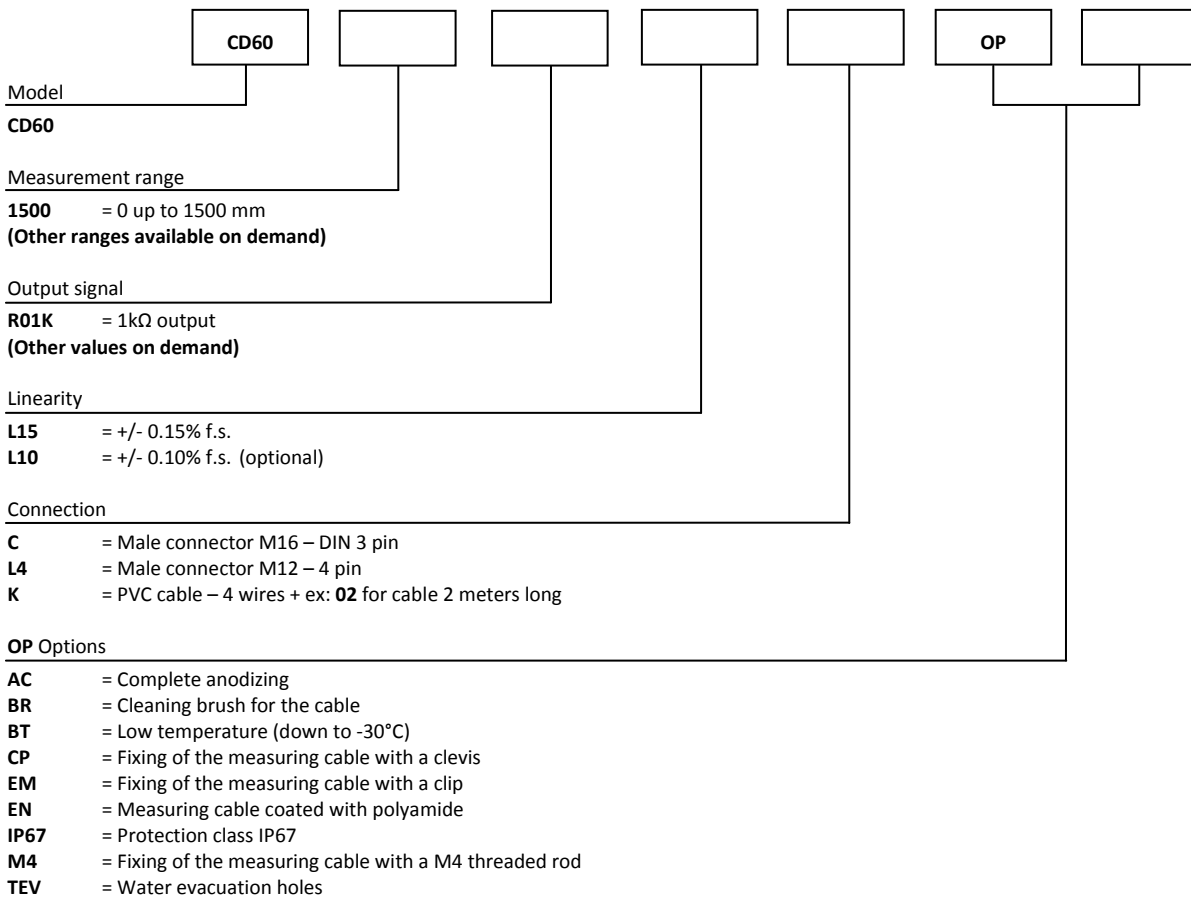

Reference example: **CD60-1500-R01K-L15-K02-OP-AC-EM**



Tel : +33 (0)3 88 02 09 02 / Fax : +33 (0)3 88 02 09 03 / E-mail : info@ak-industries.com / Web : http://www.ak-industries.com

Electrical characteristics :

Potentiometric version 1 kΩ : (other values on demand)

Temperature drift +/-50 ppm/°C

Example of wiring diagram with input stage :

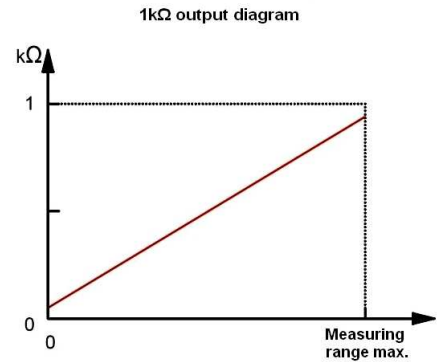
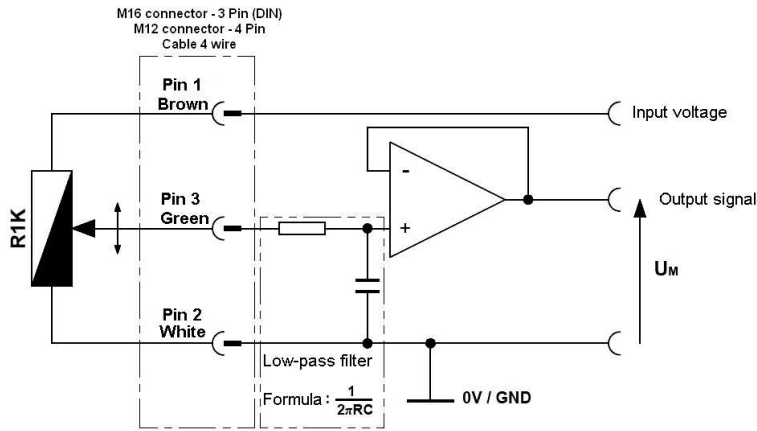

To ensure a good linearity, wire the potentiometer as a voltage divider and never as a rheostat. The input resistance of the operating system must be very high (greater than 10MΩ)

Connection :

Male connector M16 3 pin (DIN)	Male connector M12 4 pin (DIN)	PVC cable 4 wire	R01K
1	1	Brown	Input voltage +
2	2	White	Input voltage GND
3	3	Green	Signal +

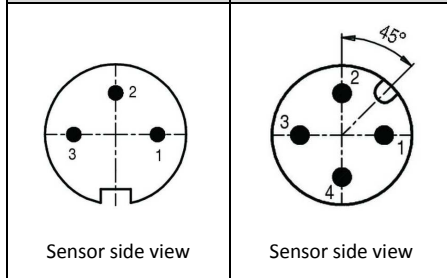

Options :

Cable attachment with a lug :

Standard

The attachment lug is fixed with a M6 screw or a clevis.

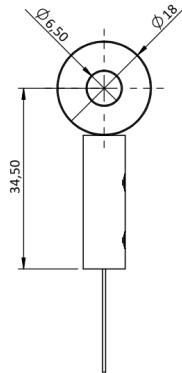

Cable attachment with a clip :

OP-EM

This fastening system allows a rotation about its axis.
The clip is fixed with a M4 screw or a clevis.

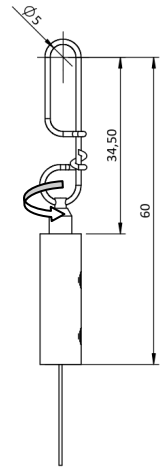

Cable attachment fitted with a M4 threaded rod:

OP-M4

The rod attachment uses a threaded rod with 2 nuts (provided).
The required thickness of the plate does not exceed 5 mm.

Caution

Never screw the threaded rod into a fixed nut, a twist of the measurement cable would damage it.

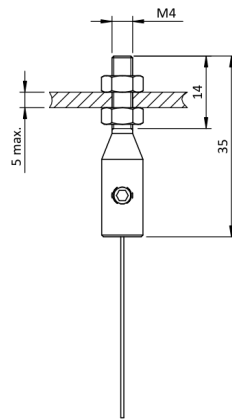

Cable attachment with a clevis :

OP-CP

The attachment of the clevis is done using a pin (provided).

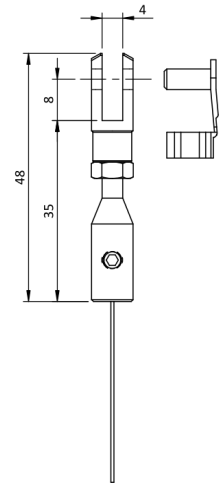

Cable cleaning brush:

OP-BR

The cleaning brush wipes the cable in dusty or humid environments.

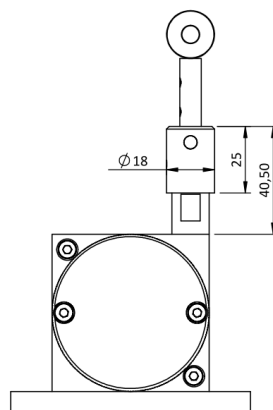

Water evacuation holes:

OP-TEV

The holes allow the natural flow of fluids out of the sensor in order to avoid their accumulation in the system.

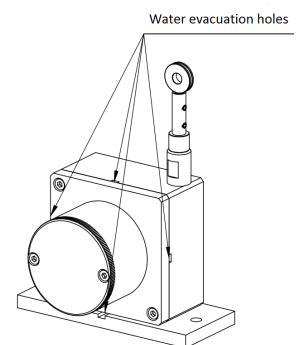

Dimensional Drawing

