

# CD60 analog output – Measurement range 0 up to 1500 mm

## Specifications:

Measurement range	0 up to 1500 mm
Output signal	0...10V (galvanic isolation) 4...20mA current loop 4...20mA current generator (galvanic isolation) 0...20mA current generator (galvanic isolation)
Resolution	Quasi infinite (depends on the operating system)
Material	Body and cover - aluminium (RohS) Measuring cable – Stainless steel
Cable diameter	0,60 mm
Detection element	Multi-turn Hybrid potentiometer
Connection	Male connector M16 – DIN 8 pin Male connector M12 – 4 pin PVC cable – 4 wires
Standard linearity	+/- 0,15% f.s. +/- 0,10% f.s. (optional)
Protection class	IP54 (option IP67)
Max. Velocity	10 m/s
Max. Acceleration	20 m/s <sup>2</sup> (before cable deformation)
Weight	≈ 1000 g
Operating temperature	-20° to +80°C
Storage temperature	-30° to +80°C



## Cable forces:

Measurement range in mm	Min. pull-out force	Max. pull-out force
1500	≈ 9,00 N	≈ 12,00 N

## Ordering reference:

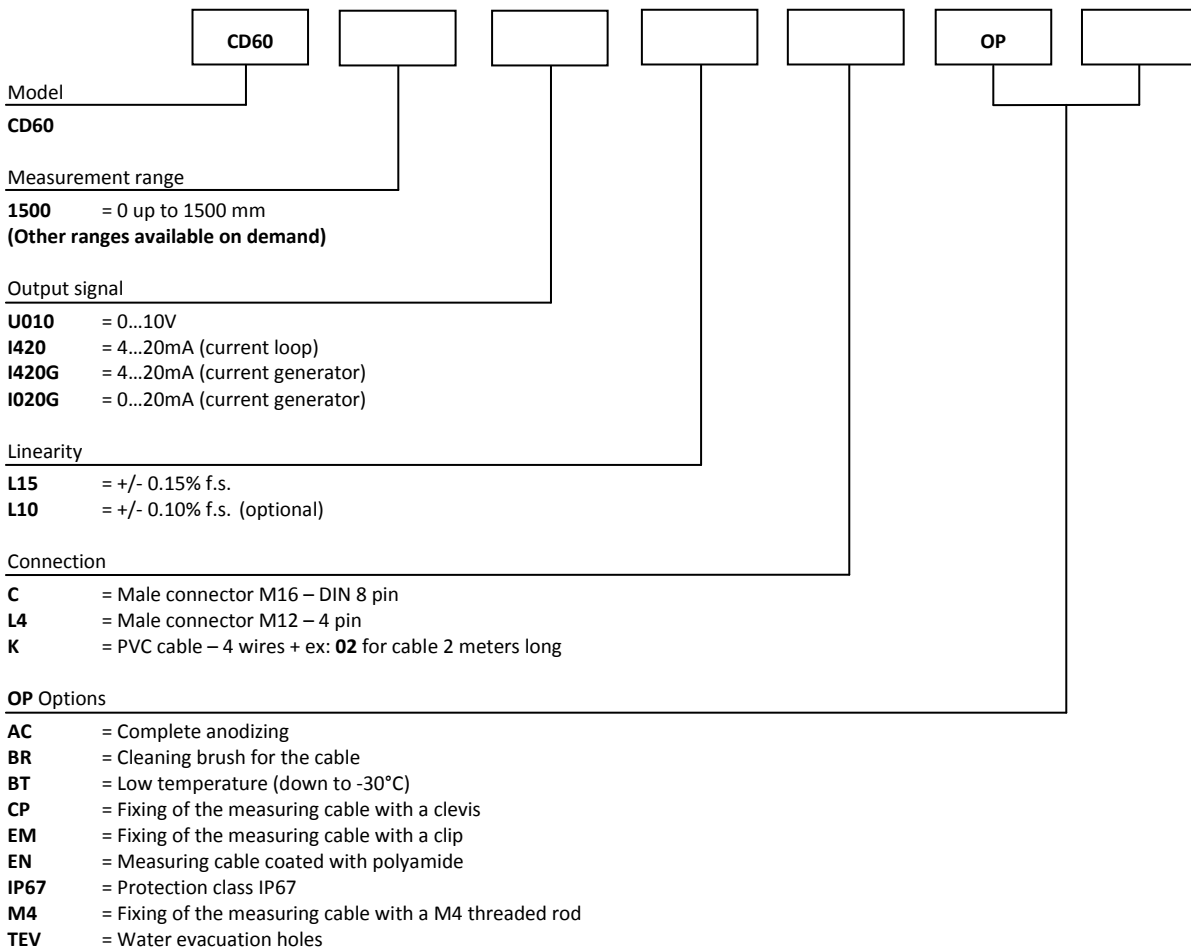

Reference example: **CD60-1500-U010-L15-K02-OP-AC-EM**



Tel : +33 (0)3 88 02 09 02 / Fax : +33 (0)3 88 02 09 03 / E-mail : [info@ak-industries.com](mailto:info@ak-industries.com) / Web : <http://www.ak-industries.com>

**Electrical characteristics :**

**Analog version 0 ... 10V :**

Input voltage 15 to +27 Vdc (52mA max)  
 Output voltage 0 to 10 Vdc  
 Output current 10mA max  
 Galvanic isolation 3KV  
 Protection - Short circuit  
 - Polarity reversal  
 Temperature drift +/-100 ppm/°C

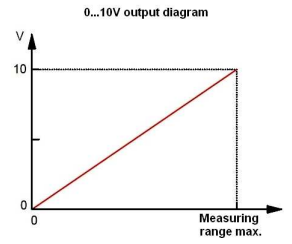
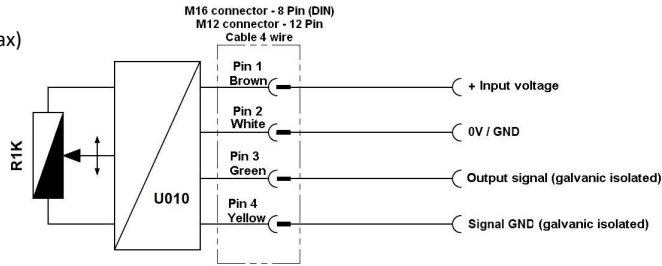

**Analog version 4 ... 20mA : (Current loop)**

Input voltage +15 to +27 Vdc (32mA max)  
 Output current 4 to 20mA  
 Protection - Short circuit  
 - Polarity reversal  
 Temperature drift +/-100 ppm/°C

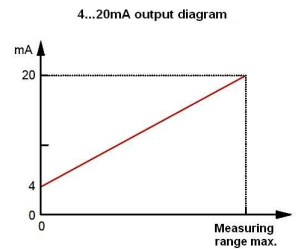
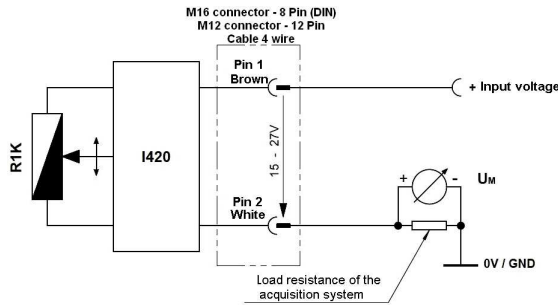

**Analog version 4...20mA or 0...20mA : (Current generator)**

Input voltage +15 to +27 Vdc (75mA max)  
 Output current 4 to 20mA or 0 to 20mA  
 Output current 22 mA max.  
 Galvanic isolation 3KV  
 Protection - Short circuit  
 - Polarity reversal  
 Temperature drift +/-100 ppm/°C

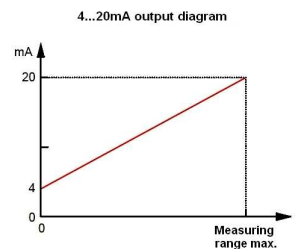
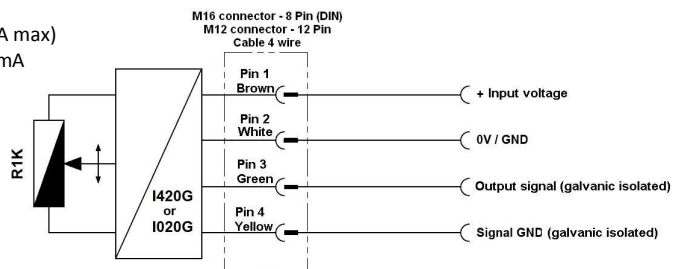

**Connection :**

Male connector M16 8 pin (DIN)	Male connector M12 4 pin (DIN)	PVC cable 4 wire	010V	I420 (current loop)	I420G or I020G (current generator)
1	1	Brown	Input voltage +	Signal +	Input voltage +
2	2	White	Input voltage GND	Signal -	Input voltage GND
3	3	Green	Signal +		Signal +
4	4	Yellow	Signal GND		Signal GND

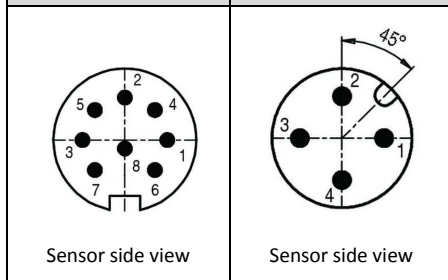

**Options :**

**Cable attachment with a lug :**

**Standard**

The attachment lug is fixed with a M6 screw or a clevis.

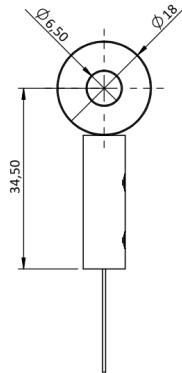

**Cable attachment with a clip :**

**OP-EM**

This fastening system allows a rotation about its axis.  
The clip is fixed with a M4 screw or a clevis.

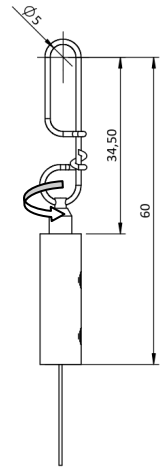

**Cable attachment fitted with a M4 threaded rod:**

**OP-M4**

The rod attachment uses a threaded rod with 2 nuts (provided).  
The required thickness of the plate does not exceed 5 mm.

**Caution**

Never screw the threaded rod into a fixed nut, a twist of the measurement cable would damage it.

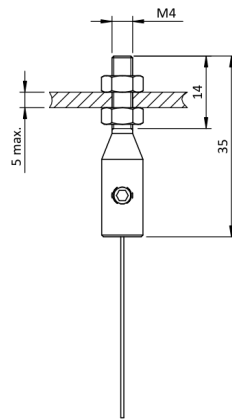

**Cable attachment with a clevis :**

**OP-CP**

The attachment of the clevis is done using a pin (provided).

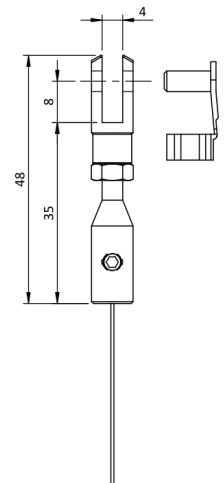

**Cable cleaning brush:**

**OP-BR**

The cleaning brush wipes the cable in dusty or humid environments.

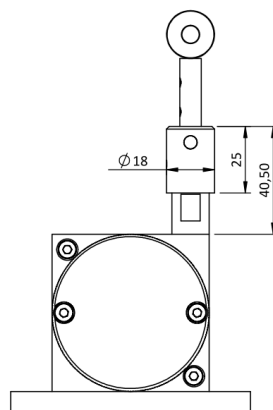

**Water evacuation holes:**

**OP-TEV**

The holes allow the natural flow of fluids out of the sensor in order to avoid their accumulation in the system.

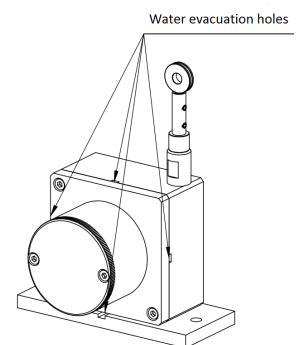

**Dimensional Drawing**

